

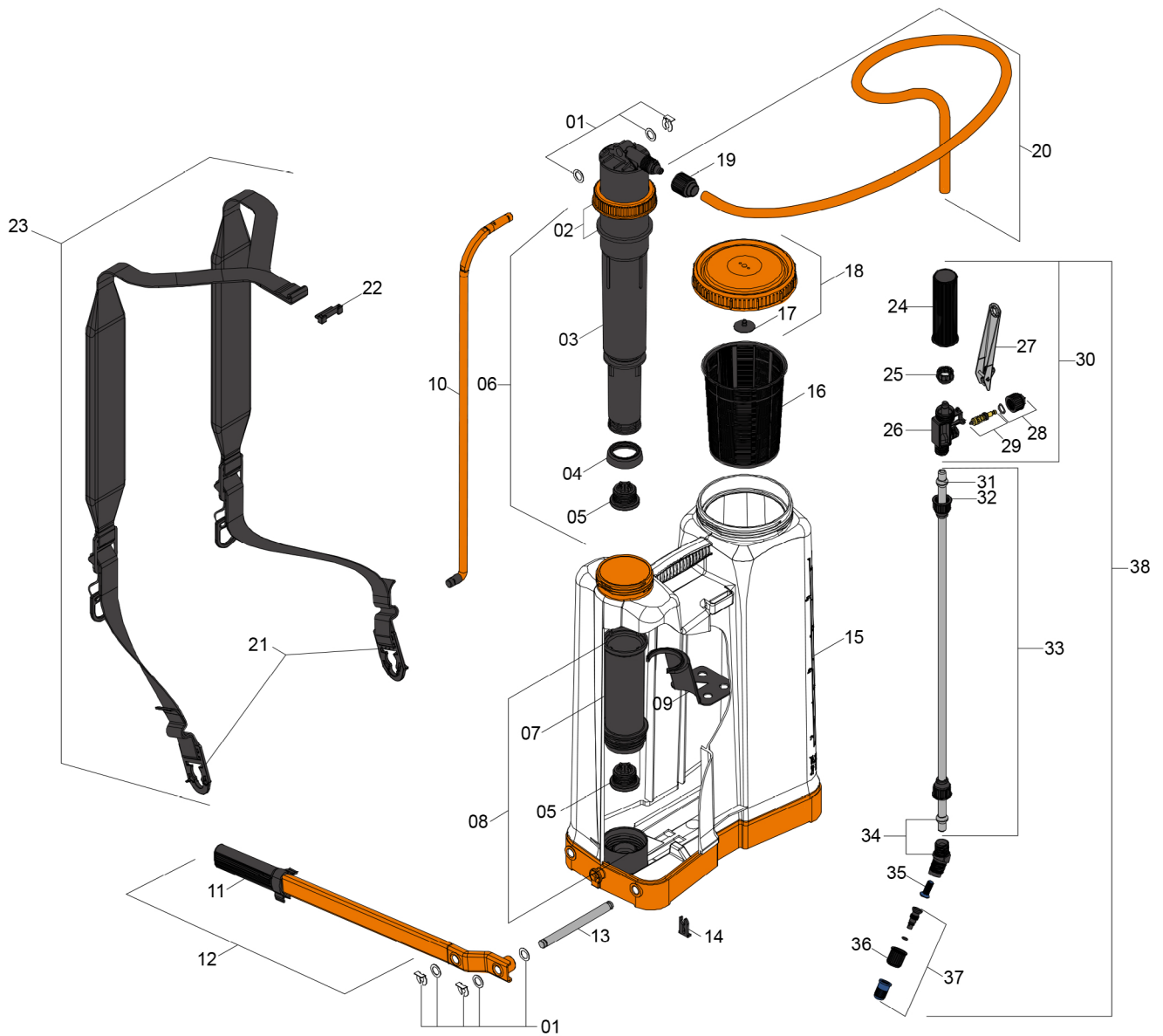

















CATÁLOGO DE PEÇAS

















PARTS CATALOG / CATÁLOGO DE PIEZAS / CATALOGUE DE PIÈCES

JACTO HD-400U



Nº	CÓDIGO CODE	DESCRIÇÃO DESCRIPTION DESCRIPCIÓN	IMAGEM IMAGE IMAGEN	QT. QTY. CT.	UTILIZAÇÃO UTILIZATION UTILIZACIÓN UTILISER	NCM HS CODE	EAN BARCODE
1	1198800	JOGO DE ARRUELAS E ANÉIS TRAVAS WASHERS AND LOCKED RINGS SET JUEGO DE ARANDELA Y ANILLO TRABA JEU DE RONDELLES ET BOULONS		10	PJ, PJH, XP, HD	7318.22.00	7909436961189
2	907121	PORTA GAXETA E GAXETA HD GASKET HOLDER AND GASKETHD PORTA PRENSAESTOPA Y PRENSAESTOPA HD PORTE-JOINT ET JOINT HD		1	HD	3926.90.90	7899144843856
3	1278245	CORPO DA CÂMARA COM ÊMBOLO U CHAMBER BODY AND PISTON CUP U CUERPO DE LA CÂMARA CON EMOLO U CORPS DE LA CHAMBRE AVEC PISTON U		1	HD-U	8424.90.90	7909436956789
4	1247522	ÊMBOLO Ø45 X 12 U PISTON CUP Ø45 X 12 U EMBOLO Ø45 X 12 U PISTON Ø45 X 12 U		20	HD-U	4016.93.00	7909436932356
5	1173630	FIXADOR DO ÊMBOLO COM ESFERA FASTENER WITH SPHERE FIJADOR DEL EMOLO CON ESFERA SOUPAPE DU BILLE		1	HD	8424.90.90	7899144894414
6	1247519	CÂMARA COMPLETA HD-U HD-U CHAMBER ASSEMBLY CAMARA COMPLETA HD-U CHAMBRE COMPLÈTE HD-U		1	HD-U	8424.90.90	7909436906081
7	635599	CORPO DO CILINDRO HD CYLINDER BODY HD CUERPO DEL CILINDRO CORPS DE CYLINDRE		1	HD	8424.90.90	7896821558348
8	277368	CILINDRO COMPLETO SEM VÁLVULA CYLINDER ASSEMBLY WITHOUT VALVE CILINDRO COMPLETO SIN VALVULA CYLINDRE COMPLÈTE SANS VALVE		1	HD	8424.90.90	7896821546468
9	1224910	MEXEDOR HD HD GITATOR MEZCLADOR HD AGITATEUR HD		5	HD	8424.90.90	7909436988056
10	1197400	HASTE LARANJA COM TRAVAS ROD WITH LOCK HASTE CON TRABA TIGE D'OPÉRATION		1	PJ, PJH, XP, HD	8424.90.90	7896660836980
11	495812	MANOPLA DA ALAVANCA COM TRAVA HANDGRIP WITH LOCK MANIJA CON TRABA MANETTE COMPLÈTE		1	PJ, PJH, XP, HD	8424.90.90	7896821573990
12	1222667	ALAVANCA DE ACIONAMENTO PUMPING LEVER PALANCA CON MANIJA LEVIER AVEC POIGNÉE		1	PJ, PJH, XP, HD	8424.90.90	7909436982283
13	293324	EIXO DA ALAVANCA LEVER SHAFT EJE DE LA PALANCA ESSIEU DU LEVIER		1	XP, HD	7318.24.00	7896821509753
14	277350	TRAVA DO EIXO HD AXIS LOCK CONTRACLAVIJA TRABA FLÉAU HD		1	XP, HD	8424.90.90	7896821567326
15	1278223	DEPÓSITO COMPLETO HD-400U HD-400U COMPLETE TANK RÉSEVOIR COMPLÈTE HD-400U		1	HD-400U	8424.90.90	7909436946872
16	1220919	COADOR TANK STRAINER COLADOR TAMIS		1	PJ, HD, PJB, DJB	8424.90.90	7896660888309
17	1280174	DIAFRAGMA DA TAMPA U LID DIAPHRAGM U DIAFRAGMA DE LA TAPAU DIAPHRAGM DE LA COUVERCLE U		50	PJ-U, HD-U, PJB-U	4016.99.90	7909436956420

JACTO HD-400U

Nº	CÓDIGO CODE	DESCRIÇÃO DESCRIPTION DESCRIPCIÓN	IMAGEM IMAGE IMAGEN	QT. QTY. CT.	UTILIZAÇÃO UTILIZATION UTILIZACIÓN UTILISER	NCM HS CODE	EAN BARCODE
18	1247526	TAMPA C/ DIAFRAGMAU LID AND DIAPHRAGM U TAPA CON DIAFRAGMA U COUVERCLE AVEC DIAPHRAGME U		1	PJ-U, HD-U, PJB-U	8424.90.90	7909436906227
19	1222648	PORCA S20 X 1,5 SCREW CAP S20 X 1,5 TUERCA S20 X 1,5 ÉCROU S20 X 1,5		10	PJH, PJ, XP, HD, PJB, DJB, DJB-S	3926.90.90	7909436943987
20	1247524	MANGUEIRA JACTO HD-U JACTO HD-U HOSE MANGUERA JACTO HD-U TUYAU JACTO HD-U		1	HD-U	8424.90.90	7909436906210
21	1220973	FIVELA HD HD BUCKLE BOUCLE HD HEBILLA HD		2	HD, PJB, DJB, DJB-S	8424.90.90	7909436915274
22	1222671	TRAVA DA CINTA STRAP LOCK TRABA DE LA CINTA LOQUET DE LA COURROIE		5	HD	8424.90.90	7909436914642
23	1256384	CINTA ALMOFADADA COM REGULAGEM HD-400 PADDED STRAP BELT WITH ADJUSTMENT HD-400 CONJUNTO DE CORREA ACOLCHADA CON REGULACIÓN HD-400 COURROIE DE PADDLE AVEC RÉGULATION HD-400		1	HD-400	8424.90.90	7909436922777
24	1220962	CABO DO REGISTRO LP 601 TRIGGER VALVE HANDLE LP 601 CABO DEL REGISTRO LP 601 POIGNÉE DU ROBINET LP 601		5	PJH, PJ, XP, HD, PJB, DJB	8424.90.90	7909436924115
25	1220966	PINÇA LP 601 CLIP LP 601 PINZA LP 601 FERMETURE LP 601		20	PJH, PJ, XP, HD, PJB, DJB	3926.90.90	7909436924474
26	1220968	CORPO DO REGISTRO LP 601 TRIGGER VALVE BODY LP 601 CUERPO DEL REGISTRO LP 601 CORPS DU REGISTRE LP 601		5	PJH, PJ, XP, HD, PJB, DJB	8481.90.90	7909436924603
27	1220951	ALAVANCA DO REGISTRO LP 601 TRIGGER VALVE LEVER LP 601 PALANCA DEL REGISTRO LP 601 LEVIER DU ROBINET LP 601		20	PJH, PJ, XP, HD, PJB, DJB	8424.90.90	7909436923989
28	1247527	TAMPA DO REGISTRO LP 601/605 COM VEDAÇÃO U TRIGGER VALVE CAP LP 601/ 605 AND SEAL U TAPA DEL REGISTRO LP 601/605 CON VEDACIÓN U COUVERCLE DU ROBINET LP 601/605 AVEC JOINT U		20	PJ-U, HD-U, PJB-U	8424.90.90	7909436906296
29	1278246	AGULHA DO REGISTRO U TRIGGER VALVE NEEDLE U AGUJA DEL REGISTRO U AIGUILLE DU ROBINET U		20	PJ-U, HD-U, PJB-U	8424.90.90	7909436962421
30	1278225	REGISTRO COMPLETO LP 601 U TRIGGER VALVE LP 601 U REGISTRO COMPLETO LP 601 U ROBINET COMPLÈTE LP 601 U		20	PJ-U, HD-U, PJB-U	8424.90.90	7909436946889
31	1220972	JUNTA CÔNICA CONE PACKING JUNTA CÔNICA CONE PACKING		20	PJH, PJ, XP, HD, PJB, DJB, DJB-S	3926.90.90	7909436925037
32	1220969	PORCA CÔNICA 11/16 SCREW CAP 11/16 TUERCA CÔNICA 11/16 ECROU CONIQUE 11/16		10	PJH, PJ, XP, HD, PJB, DJB, DJB-S	3926.90.90	7909436924924
33	100131	TUBO DE PULVERIZAÇÃO STAINLESS STEEL LANCE TUBO DE PULVERIZACIÓN TUBE DE PULVÉRISATION		1	PJH, PJ, XP, HD, PJB, DJB	8424.90.90	7896821501252
34	635276	JUNÇÃO E JUNTA CÔNICA JOINT AND CONE PACKING UNIÓN CON JUNTA CÔNICA JOINT AND CONE PACKING		10	PJH, PJ, XP, HD, PJB, DJB, DJB-S	3917.40.90	7909436931311

Nº	CÓDIGO CODE	DESCRIÇÃO DESCRIPTION DESCRIPCIÓN	IMAGEM IMAGE IMAGEN	QT. QTY. CT.	UTILIZAÇÃO UTILIZATION UTILIZACIÓN UTILISER	NCM HS CODE	EAN BARCODE
35	1168545	FILTRO DO BICO M50/60 NOZZLE FILTER M50/60 FILTRO DE LA BOQUILLA M50/60 FILTRE DE LA BUSE M50/60		20	PJH, PJ, XP, HD, PJB, DJB, DJB-S	8421.29.19	7896660860053
36	1168546	CAPA DO BICO NOZZLE CAP CAPA DE LA BOQUILLA COUVERCLE DE LA BUSE		30	PJH, PJ, XP, HD, PJB, DJB, DJB-S	8424.90.90	7909436925310
37	1222664	BICO CONE REGULÁVEL AZUL BLUE ADJUSTABLE CONE NOZZLE BOQUILLA CONO AJUSTABLE AZUL BUSE CÔNE RÉGLABLE BLEU		10	PJH, PJ, XP, HD, PJB, DJB	8424.90.90	7909436928588
38	1247523	LANÇA COMPLETA U LANCE AND TRIGGER VALVE U LANZA COMPLETA U LANCE COMPLÈTE U		1	PJ-U, HD-U, PJB-U	8424.90.90	7909436906104